

Exalto

WIPER TECHNOLOGIES

WIPER SYSTEMS

Exalto windscreen wiper type 215BD

ITEM NO. 2151225/50/75IER (12V) / 2152425/50/75IER (24V)



CLEARLY
THE BEST



Content



Warning: please disconnect the electrical circuit before performing maintenance to your wiper.

Inhoudsopgave



Waarschuwing: zorg ervoor dat de stroom is losgekoppeld als u werkzaamheden aan de wisser uitvoert.



Dimensions and electrical scheme

Maten en aansluitschema

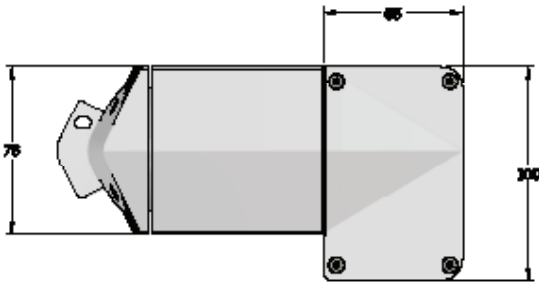

Colour	Function	Pol
White/Blue	Fast	+
White/Red	Self-park	+
White/Green	Slow	+
White	Minus	-

12V - 5A Fuse
24V - 3A Fuse

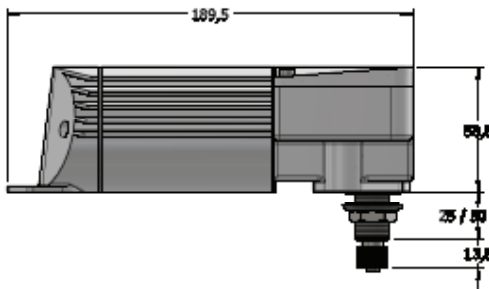

72 teeth 60°
OD Ø13.85
toothdepth 0.49mm

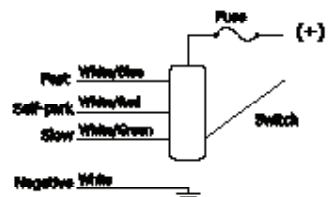
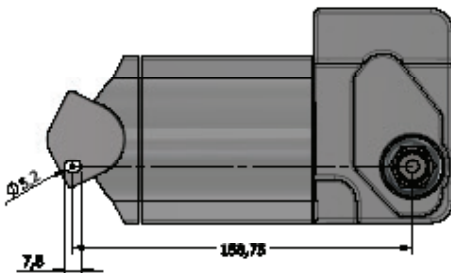
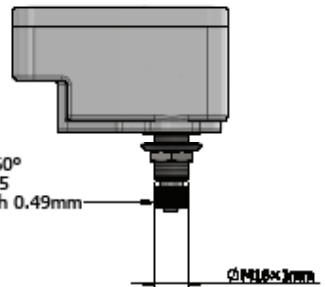



Adjusting the wiper arc

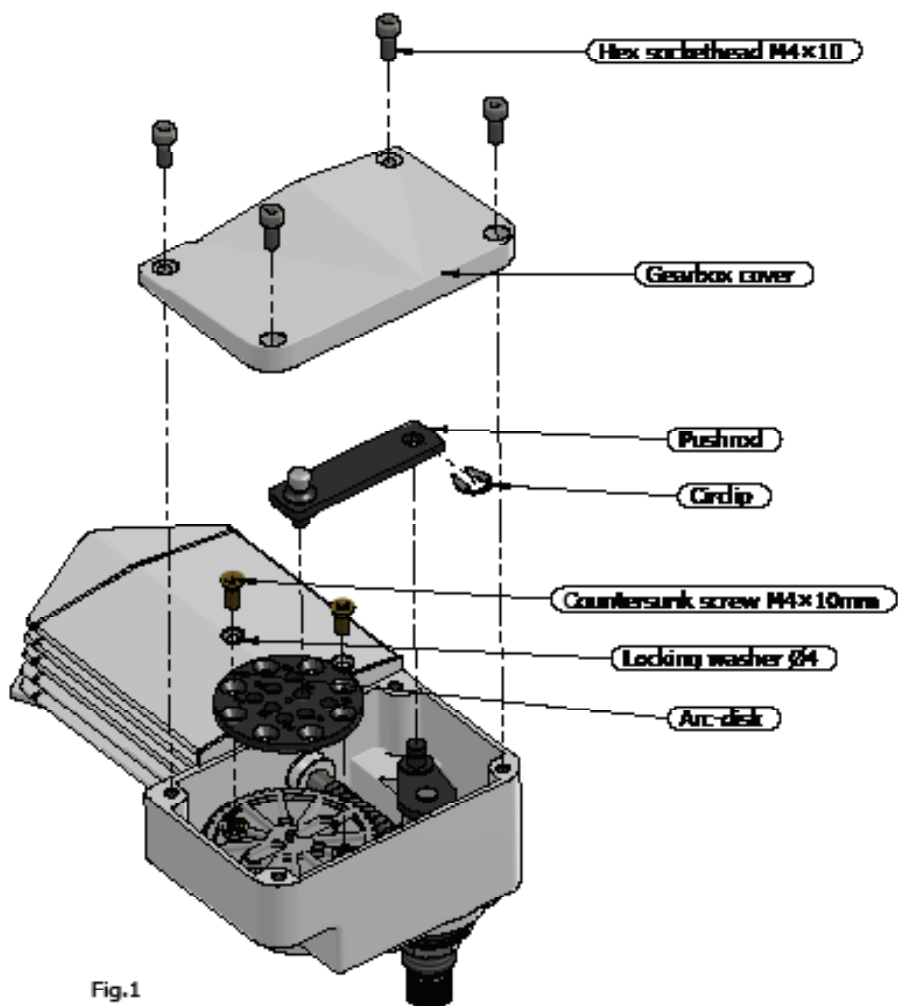



Adjusting the wiper arc

Adjusting the wiper arc. (default preset at 40°)

To adjust the wiper-arc follow the next steps.

1. Remove the gearbox cover. (fig.1)
2. Detach the circlip and disconnect the pushrod. (fig.1)
3. Unscrew the arc-disk, mind the locking washers! (fig.1)
4. Turn the arc-disk on to the desired arc, line up with chosen parking slot. (fig.2 and 3)
5. Fix the arc-disk by tightening the screws.
6. Reconnect the pushrod and secure it with the circlip.
7. Replace the gearbox cover.

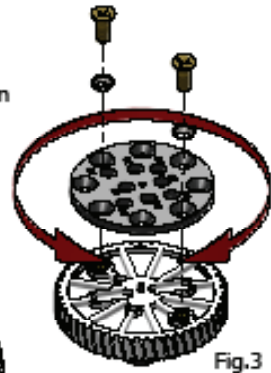
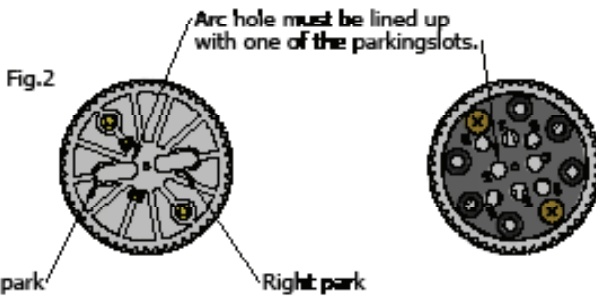

Fig.3

NOTE:

Please pay special attention to the parking position, the hole of the desired arc must be lined up to one of the parking-slots in the gearwheel. Depending on the mounting position, left and right can be reversed.

Colour	Function	Pol
White/Blue	Fast	+
White/Red	Self-park	+
White/Green	Slow	+
White	Minus	-

Tab.1

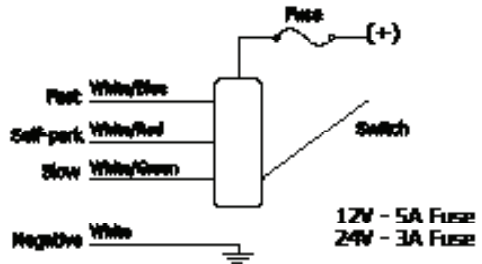
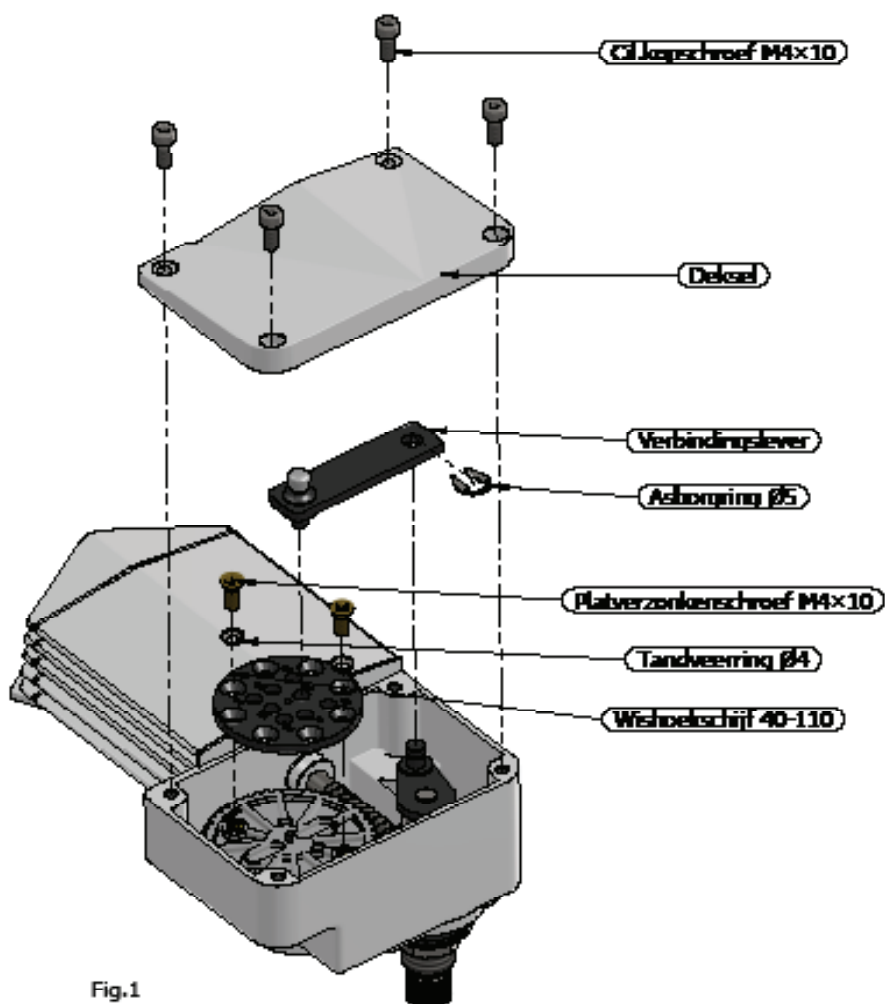

Fig.4



Verstellen van de wishoek





Verstellen van de wishoek

Verstellen van de wishoek. (standaard op 40°)

Om de wishoek te verstellen volg de onderstaande stappen.

1. Verwijder het deksel. (fig.1)
2. Schuif de asborgring van de as en haal het verbindingslever weg.
3. Schroef de wishoekschijf los, let op de tandveerringen!!.
4. Draai de wishoekschijf naar de gewenste wishoek en parkeerstand, zorg ervoor dat het gat in lijn ligt met de goede sleuf (fig 2 & 3)
5. Schroef de wishoekschijf weer goed vast.
6. Monteer het verbindingslever en de asborgring weer.
7. Zet het deksel weer terug op de wisser.



Let op:

Het gekozen wishoekgat moet in lijn liggen met één van de onderliggende sleuven, let daarbij op de parkeerstand.

Afhankelijk van de montageplaats van de wisser kan links en rechts omgedraaid zijn!

Kleur	Functie	Pol
Wit/Blauw	Snel	+
Wit/Rood	Zelf-parkeer	+
Wit/Groen	Langzaam	+
Wit	Min	-

Tab.1

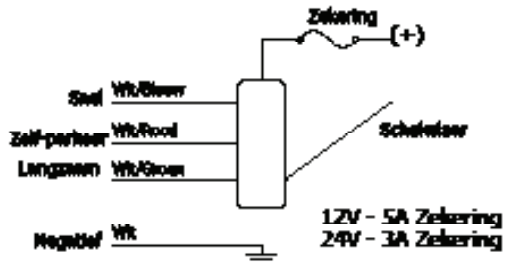
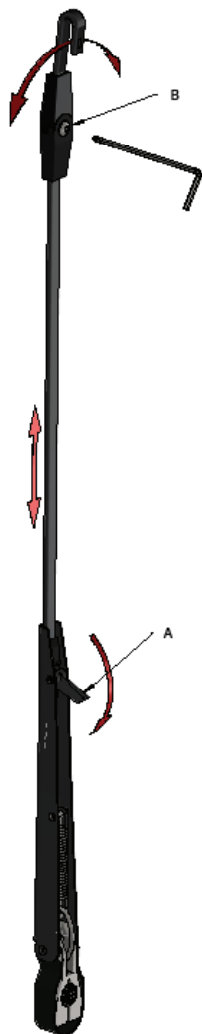

Fig.4

Adjusting the pendulum arm length De lengte van de enkele arm instellen



How to adjust the blade angle of the single arm.

- 1.- Unscrew the sockethead screw with a fitting socket wrench.
- 2.- Adjust the head to the desired angle.
- 3.- Tighten sockethead screw B firmly again.

Hoe de bladhoek van de enkele arm aan te passen.

- 1.- Draai inbusbout B los met een passende inbussleutel.
- 2.- Stel de gewenste hoek in.
- 3.- Draai inbusbout B weer stevig aan.

How to adjust the length of the single arm.

- 1.- Pull lever A up to unlock the arm.
- 2.- Adjust both arms to the desired length.
- 3.- Push lever A back in the original position.

Hoe de lengte van de enkele arm aan te passen.

- 1.- Trek hendel A omhoog om de arm te ontgrendelen.
- 2.- Stel de gewenste lengte in.
- 3.- Druk hendel A weer terug.



Mounting/removing the pendulum arm Monteren/demonteren van de enkele arm

Single Arm

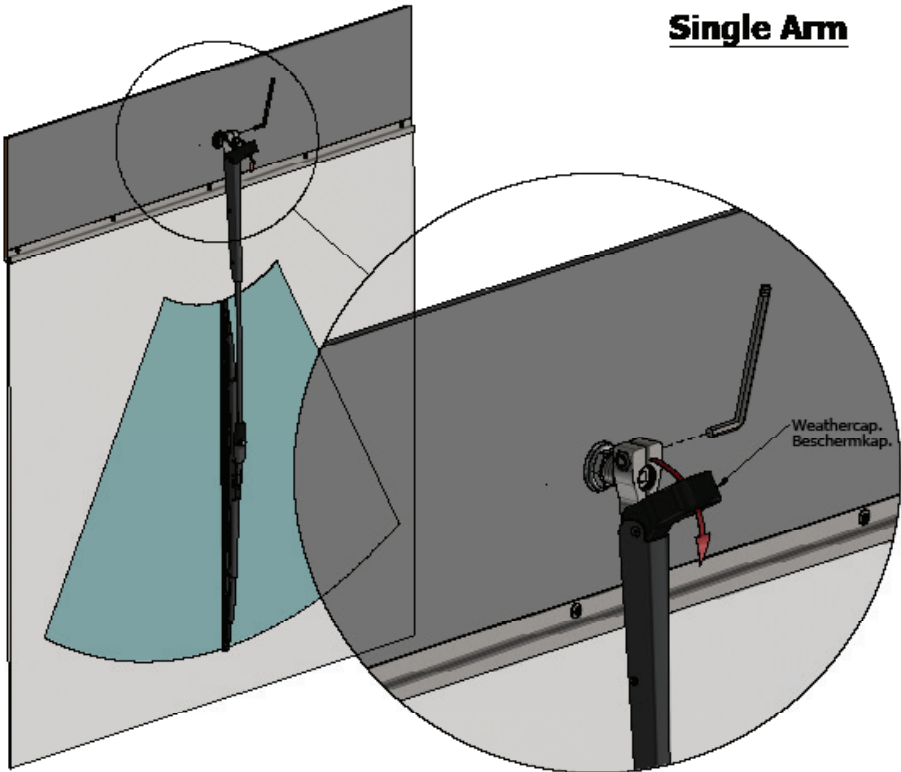

How to dismount the single arm:

- 1 - To get access to the socket head screw, the weathercap must be pulled forward.
- 2 - Loosen the socket head screw in order to pull the arm of the wiper spindle.
- 3 - Pull the arm gently off the spindle.

Demonteren van een single arm:

- 1 - Om toegang te krijgen tot de inbusbout, trek dan eerst de beschermkap naar voren.
- 2 - Draai vervolgens de inbusbout los zodat de arm van de aangedreven as gehaald kan worden.
- 3 - Trek voorzichtig de arm van de wisser-as.

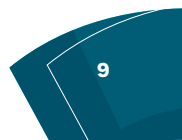



Adjusting the pantograph arm length

De lengte van de parallel arm instellen

How to adjust the length of the pantograph arm.

- 1.- Pull lever A up to unlock the arm and loosen nut B with a wrench Nr.10
- 2.- Adjust both arms to the desired length
- 3.- Push lever A back in the original position and tighten nut B

Hoe de lengte van de parallel arm aan te passen.

- 1.- Trek hendel A omhoog om de arm te ontgrendelen
Draai moer B los met behulp van een steeksleutel 10mm
- 2.- Stel de gewenste lengte in
- 3.- Druk hendel A weer terug en draai moer B weer stevig aan

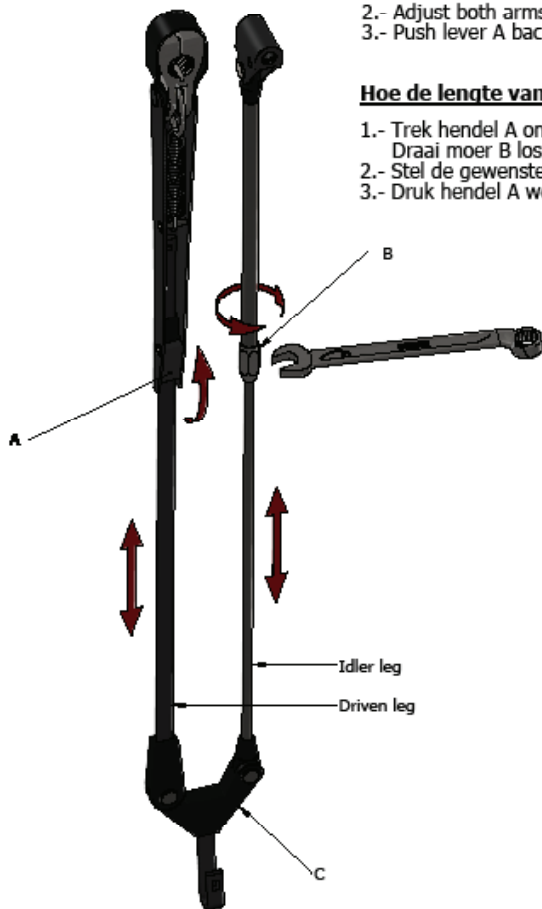



Mounting/removing the pantograph arm

Monteren/demonteren van de parallel arm

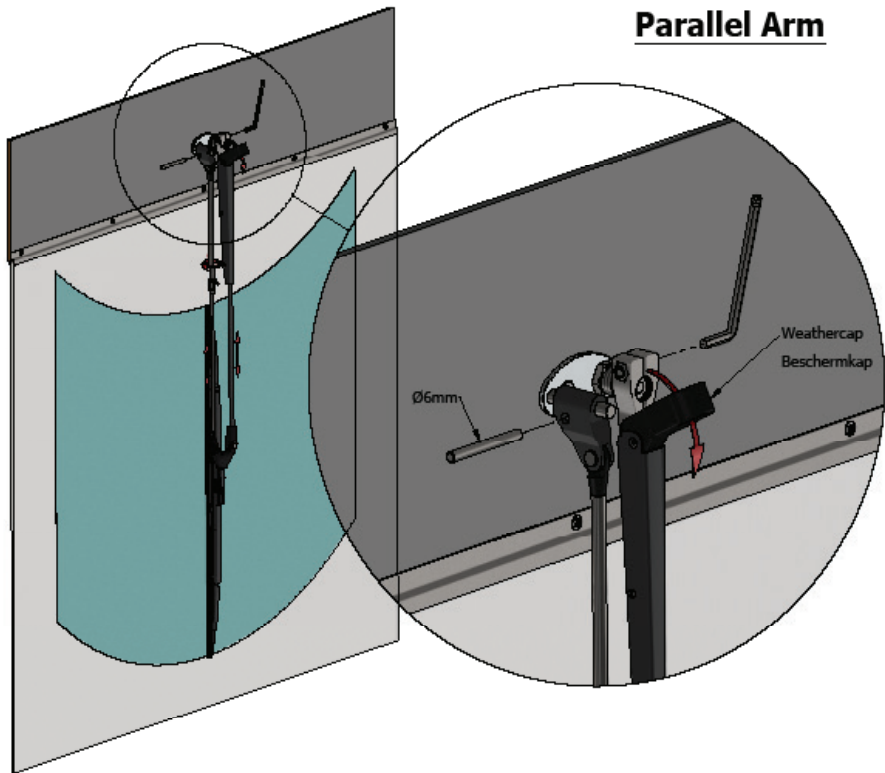

How to remove the parallel arm:

- 1 - To get access to the socket head screw, the weathercap must be pulled forward.
- 2 - Loosen the socket head screw in order to pull the arm of the wiper spindle.
- 3 - Press a rod $\varnothing 6\text{mm}$ into the side hole to dislock the idler leg of the wiper arm.
- 4 - Pull the arm of the spindles.

Demonteren van een parallelarm:

- 1 - Om toegang te krijgen tot de inbusbout, trek dan eerst de beschermkap naar voren.
- 2 - Draai vervolgens de inbusbout los zodat de arm van de aangedreven as gehaald kan worden.
- 3 - Druk een staaf van $\varnothing 6\text{mm}$ in het gat aan de zijkant om de blokkering van de onaangedreven as op te heffen.
- 4 - Trek de arm van de wisser-assen.



CLEARLY THE BEST

Hereby declares that Exalto windscreen wiper type 215BD complies to the following harmonised standards:

Pleasure yachts electric systems

- NEN-EN-ISO 10133:2017 Extra-low voltage D.C. installations (regarding color codes)

Exalto Wiper Technologies

P.O. Box 40
3370 AA Hardinxveld-Giessendam
The Netherlands

+31 (0)85 203 1700
wipers@exalto.com

exaltowipers.com